

## Slak-T SYSTEM

**APPLICAZIONI sistema telescopico - APLICACIÓN sistema telescópico  
APPLICATIONS telescopic system - ANWENDUNGEN teleskopisches System**

### B05E52

Versione a parete - 2 ante mobili - Versión de pared. 2 puertas correderas  
Wall version. 2 moving glazings - Wandvariante. 2 beweglichen Türflügel

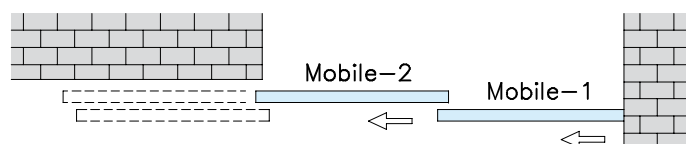

### B05E54

Versione a parete - 4 ante mobili - Versión de pared. 4 puertas correderas  
Wall version. 4 moving glazings - Wandvariante. 4 beweglichen Türflügel.

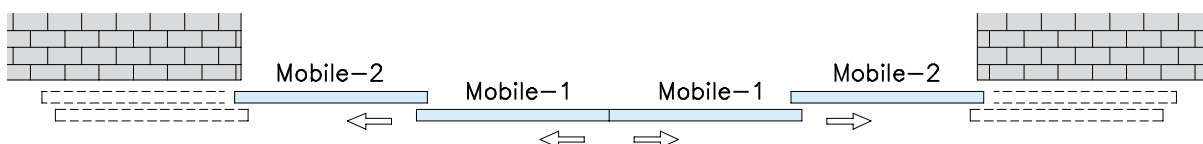

### B05E73

Versione a soffitto. 3 ante : 2 mobili e 1 fissa - Versión de techo. 3 puertas: dos  
correderas y una fija - Ceiling version. 3 glazings: 2 moving and 1 fixed -  
Deckevariante. 3 Türflügel: 2 beweglich und 1 fest

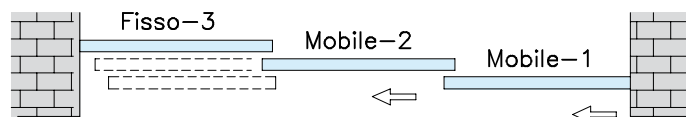

### B05E76

Versione a soffitto. 6 ante : 4 mobili e 2 fisse - Versión de techo. Seis puertas: 4  
correderas y dos fijas - Ceiling version. 6 glazings: 4 moving and 2 fixed -  
Deckevariante. 6 Türflügel: 4 beweglich und 2 fest

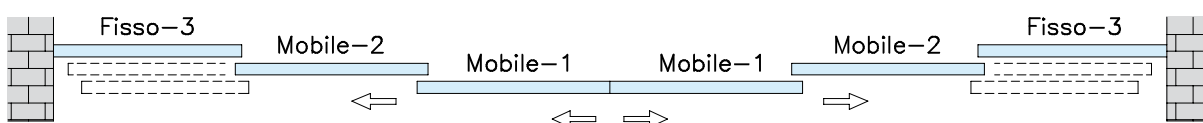

#### B05E52 - B05E54

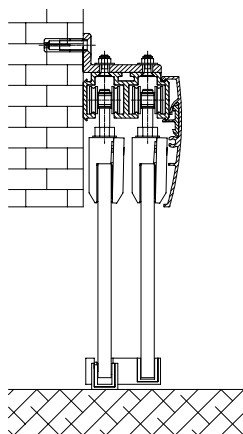

#### B05E73 - B05E76

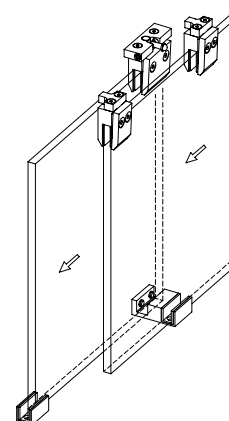
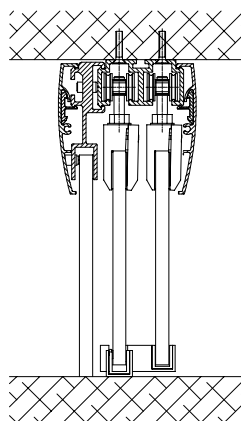

## B05E52



- Set Slak-T scorrevole telescopico. Versione a parete. 2 ante mobili.
- kit slak-t telescópico – corredo. Versión de pared. Dos puertas correderas
- Slak-T set. Telescopic sliding. Wall version. 2 moving glazings.
- Set Slak-T. Teleskopisches Schiebesystem. Wandvariante. 2 beweglichen Türflügel.

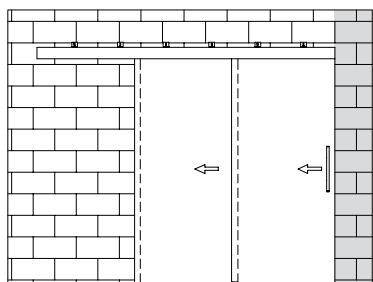

### Compreso

#### 1x B05EP11

2 x B905

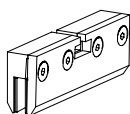

2 x BS10



2 x BS30



2 x B05EP14



#### 1x B05EP12

2 x B905

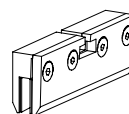

2 x BS10



2 x BS30



1 x B05EP13



1 x B05EP55



1 x BN50



Included

### Non compreso

B05EP80  
1 x 400mm.

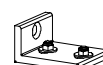

B05EP40  
B05EP40-3 (3mt.)  
B05EP40-6 (6mt.)

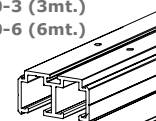

BS45  
BS45-3 (3mt.)  
BS45-6 (6mt.)

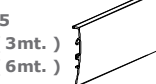

1 x B05EP60

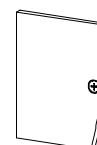

5BN0



Not included

## B05E54



- Set Slak-T scorrevole telescopico. Versione a parete. 4 ante mobili.
- kit slak-t telescópico – corredo. Versión de pared. Cuatro puertas correderas
- Slak-T set. Telescopic sliding. Wall version. 4 moving glazings.
- Set Slak-T. Teleskopisches Schiebesystem. Wandvariante. 4 beweglichen Türflügel.

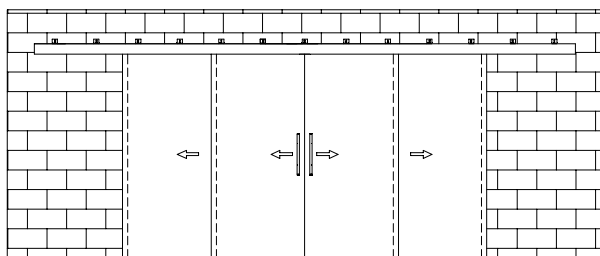

### Compreso

#### 2x B05EP11

2 x B905

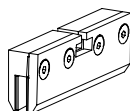

2 x BS10



2 x BS30



2 x B05EP14



#### 2x B05EP12

2 x B905

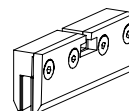

2 x BS10



2 x BS30



1 x B05EP13



1 x B05EP55



1 x BN50



Included

### Non compreso

B05EP80  
1 x 400mm.

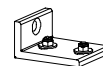

B05EP40  
B05EP40-3 (3mt.)  
B05EP40-6 (6mt.)

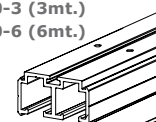

BS45  
BS45-3 (3mt.)  
BS45-6 (6mt.)

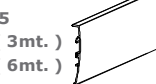

2 x B05EP60

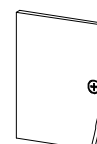

5BN0



Not included

## B05E73

8mm  
10mm

- Set Slak-T scorrevole telescopico. Versione a soffitto. 3 ante: 2 mobili e 1 fissa.
- kit slak-t telescópico – corredero. Versión de techo. Tres puertas: dos correderas y una fija
- Slak-T set. Telescopic sliding. Ceiling version. 3 glazings: 2 moving and 1 fixed.
- Set Slak-T. Teleskopisches Schiebesystem. Deckevariante. 3 Türflügel: 2 beweglich und 1 fest

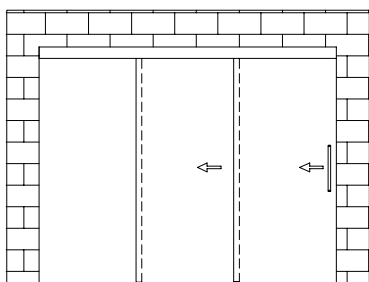

### Compreso

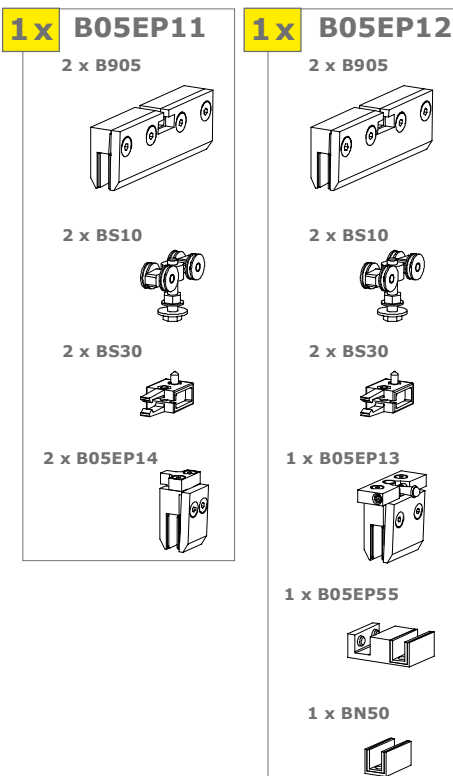

Included

### Non compreso

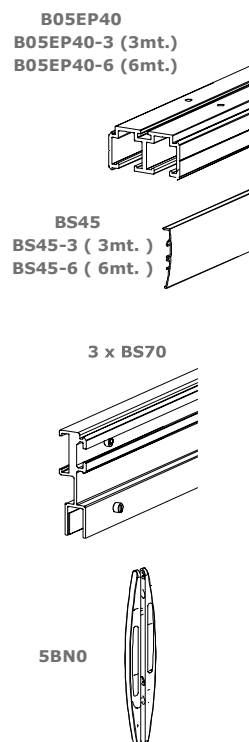

Not included

## B05E76

8mm  
10mm

- Set Slak-T scorrevole telescopico. Versione a soffitto. 6 ante: 4 mobili e 2 fisse.
- kit slak-t telescópico – corredero. Versión de techo. Seis puertas: cuatros correderas y dos fijas
- Slak-T set. Telescopic sliding. Ceiling version. 6 glazings: 4 moving and 2 fixed.
- Set Slak-T. Teleskopisches Schiebesystem. Deckevariante. 6 Türflügel: 4 beweglich und 2 fest.

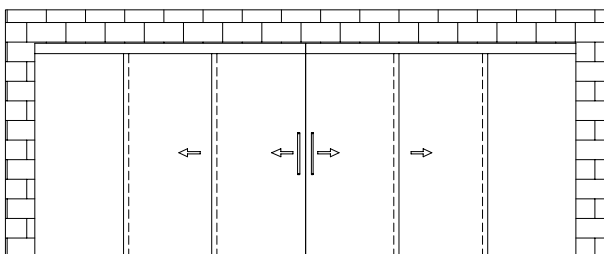

### Compreso

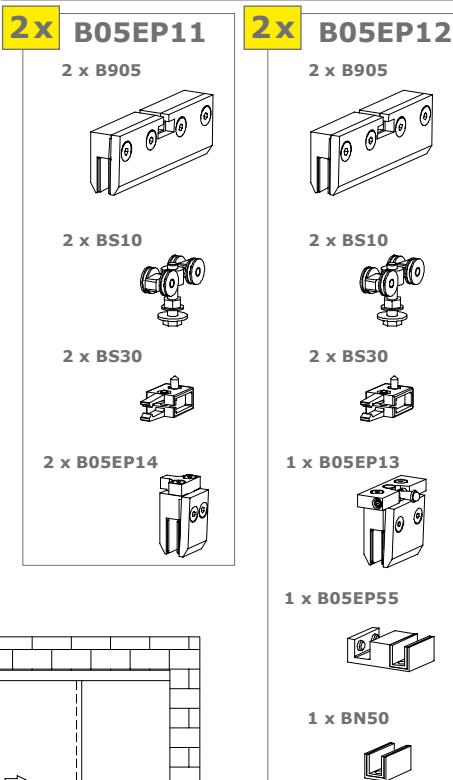

Included

### Non compreso

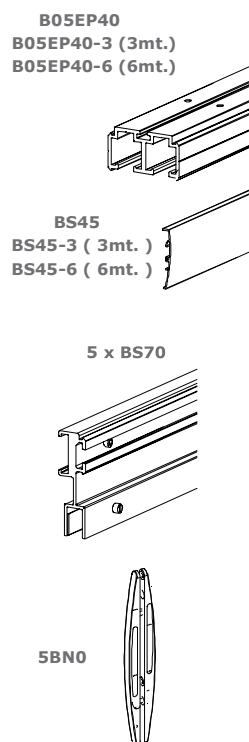

Not included

## B05EP40

- Binario a 2 vie L = 3/6 mt.
- Binario de dos vias L = 3/6 mt.
- 2-ways rail L = 3/6 mt.
- 2-wege Schiene L = 3/6 mt.

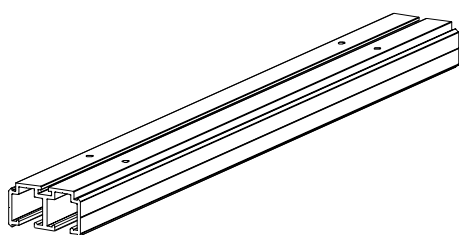
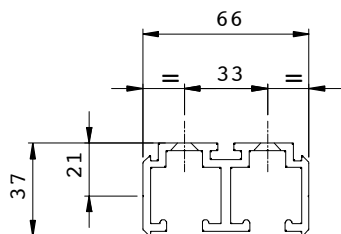

$$L \text{ barra} = L \text{ vano} + 100 + \left( \frac{L \text{ vano}}{n^{\circ} \text{ vetri}} \right)$$

$$L \text{ bar} = L \text{ space} + 100 + \left( \frac{L \text{ space}}{n^{\circ} \text{ glasses}} \right)$$

## BS45

- Veletta Slak L = 3/6 mt.
- Cárter "Slak" L = 3/6 mt.
- Slak spandrel panel. L = 3/6 mt.
- Anlauf Slak. L = 3/6 mt.

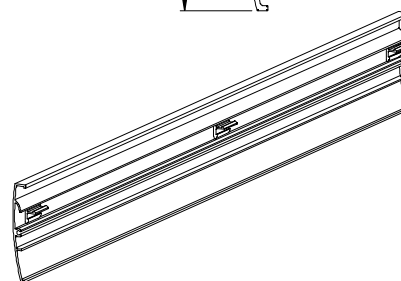
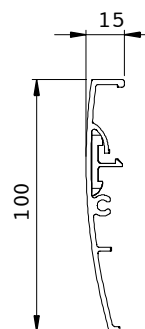

## B05EP60

- Tappo binario a due vie.
- Tapa por carril de dos vias.
- Cap for 2-ways rail.
- Deckel für 2-wege Schiene.

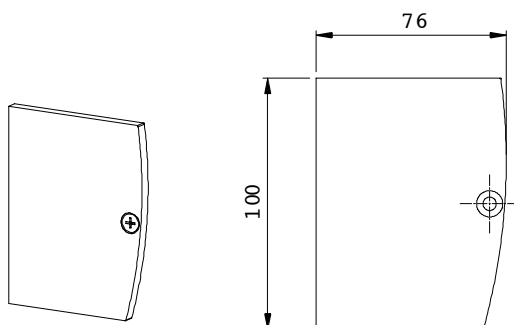
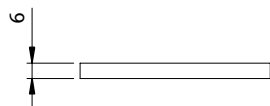

## BS70

- Supporto fisso Slak L=300mm.
- Soporte Slak de fijo de L=300mm.
- Slak fixed support. L=300mm.
- Slak Schiene für feste Gehäuse L=300mm.

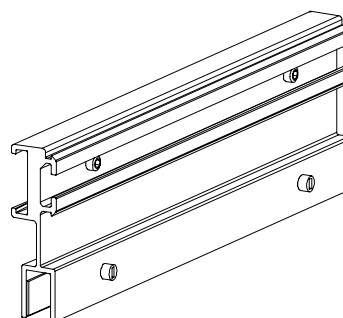
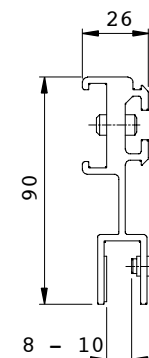

## B05EP80

- Staffa di fissaggio a parete. Una ogni 400mm.
- Abazadera de ajuste a pared. Una pieza, cada 400mm.
- Wall fixing plate. One each 400mm.
- Wandbefestigungsplatte. Eine jede 400mm.

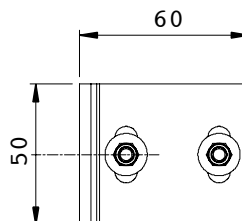
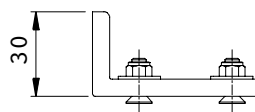
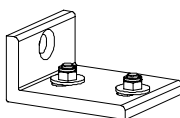

Sistema Slak-T - Sistema Slak-T - Slak-T system - Slak-T System

1000mm

MAX 75kg

**B905  
STANDARD**

1000 ÷ 1200mm

MAX 120kg

**B905  
+ OPTIONALS**

>1200mm

MAX >120kg

**+N B905  
+ OPTIONALS**

**B05E52**

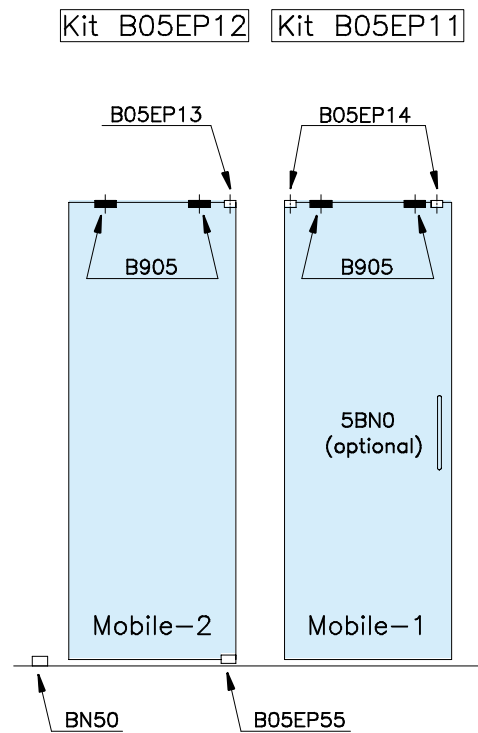
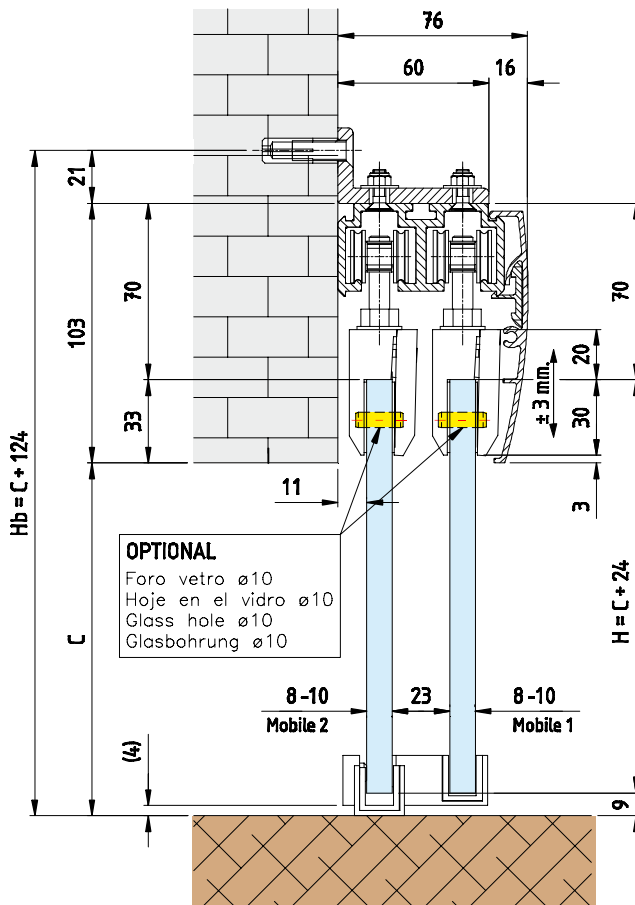
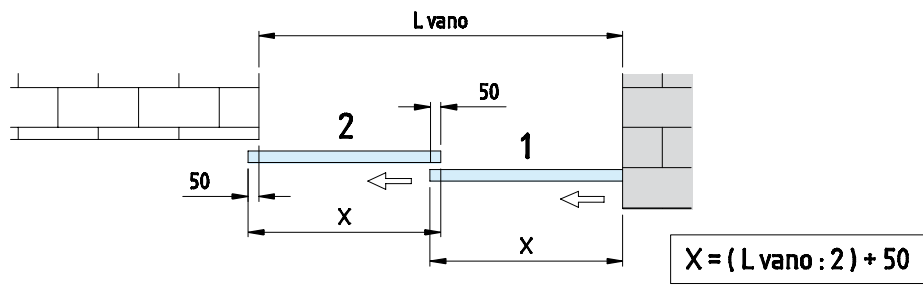
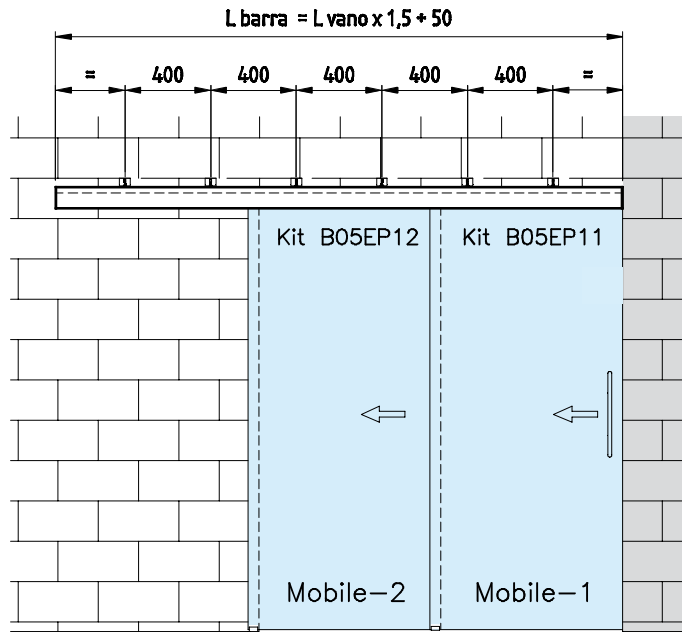

Sistema Slak-T - Sistema Slak-T - Slak-T system - Slak-T System

**B05E54**

In caso di dimensioni della barra superiore a 6mt. utilizzare due barre  
In case of bar dimensions higher than 6mt. use 2 bars

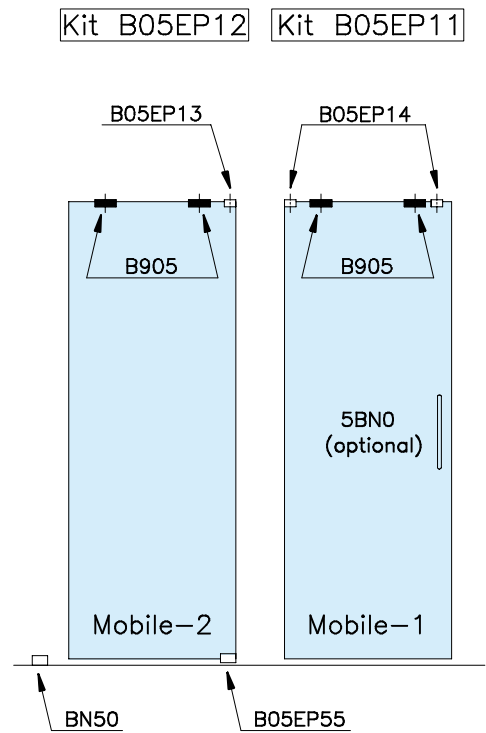
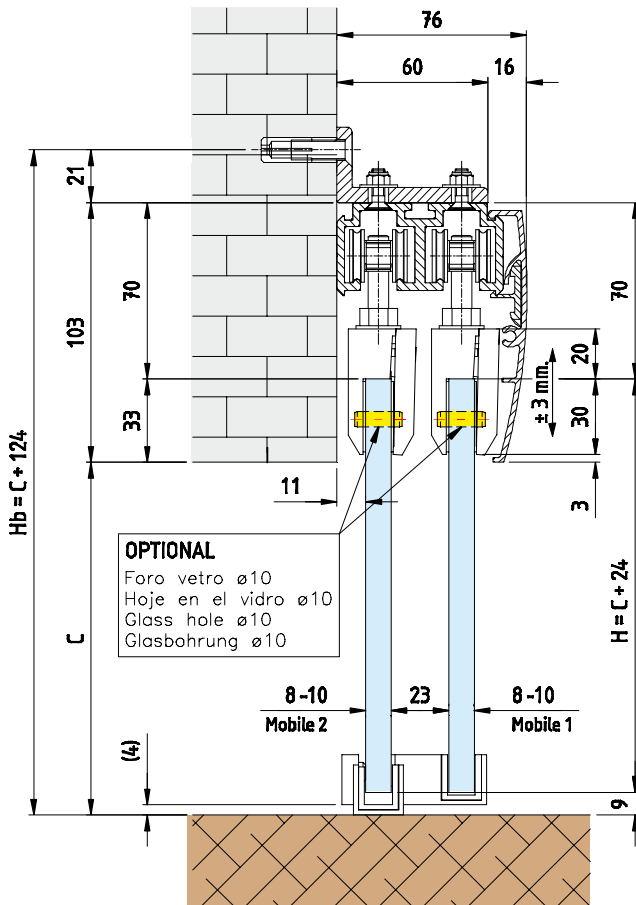
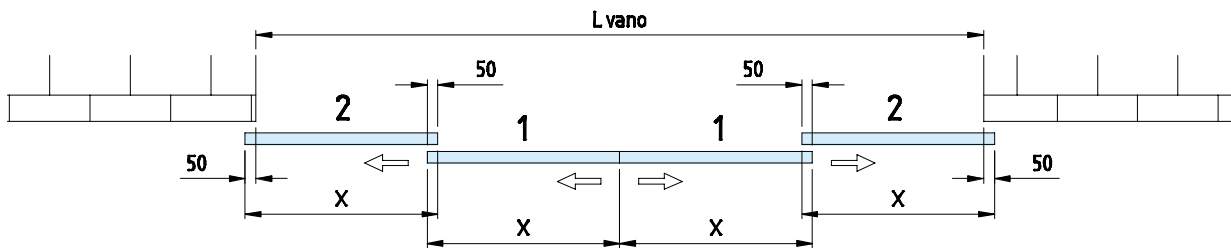
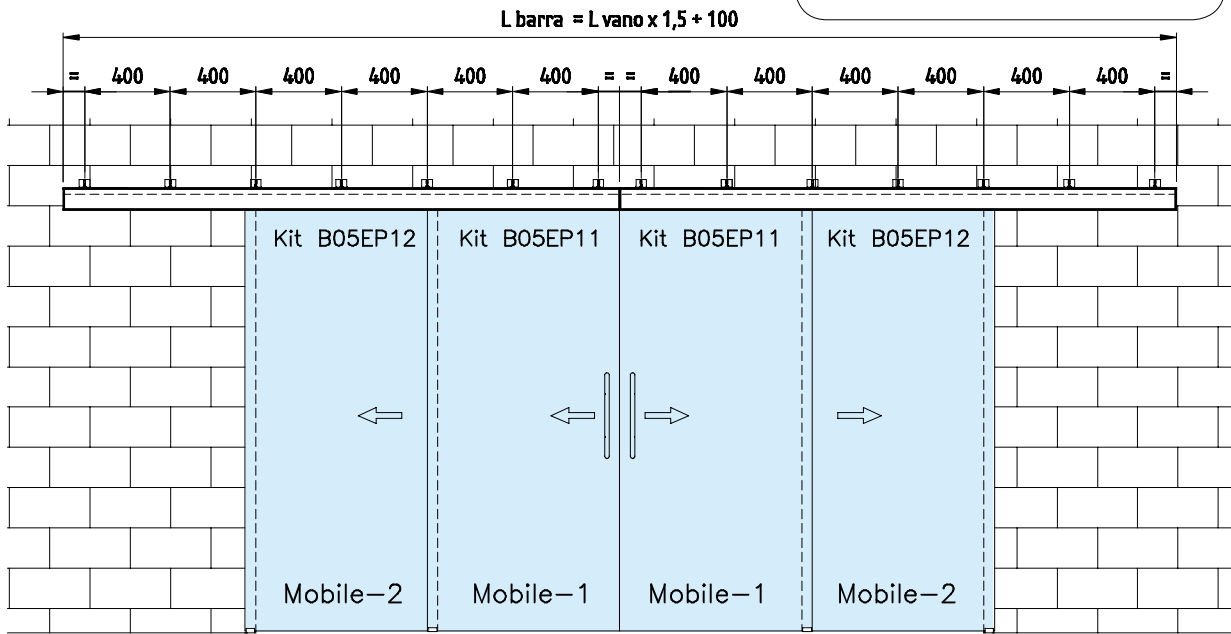

Sistema Slak-T - Sistema Slak-T - Slak-T system - Slak-T System

B05E73

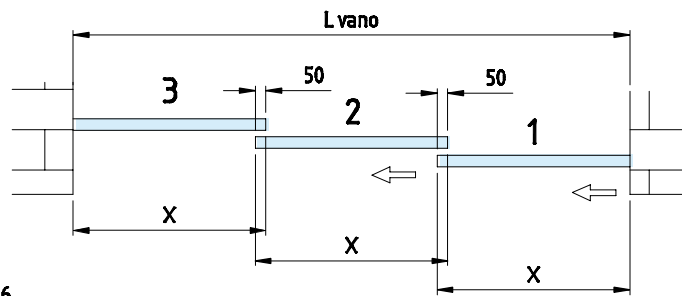
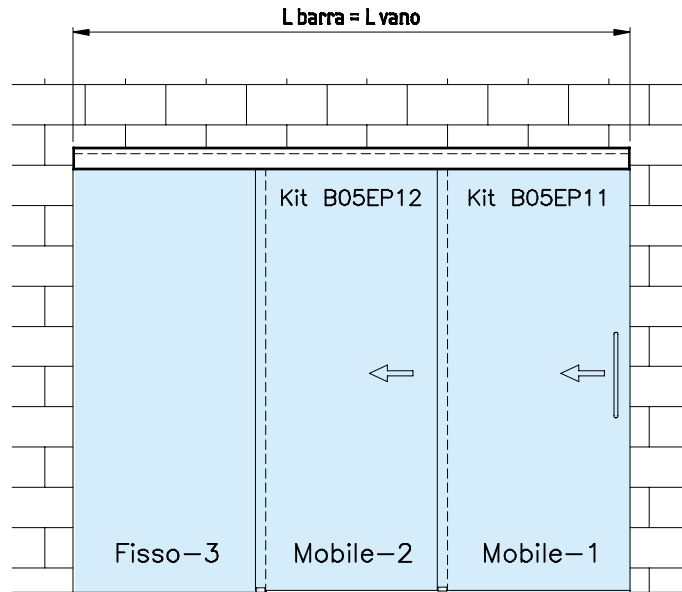

$X = (L \text{ vano} : 3) + 33$

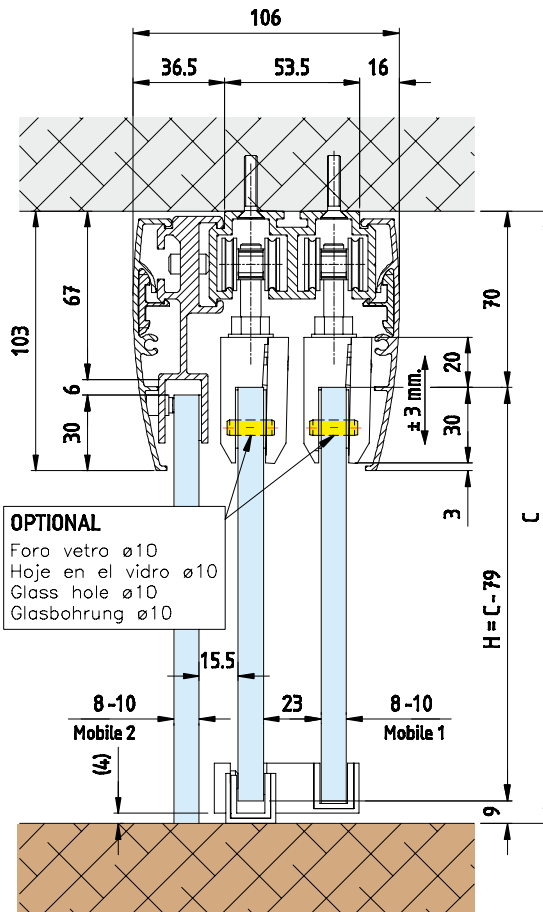

**OPTIONAL**  
Foro vetro ø10  
Hoje en el vidrio ø10  
Glass hole ø10  
Glasbohrung ø10

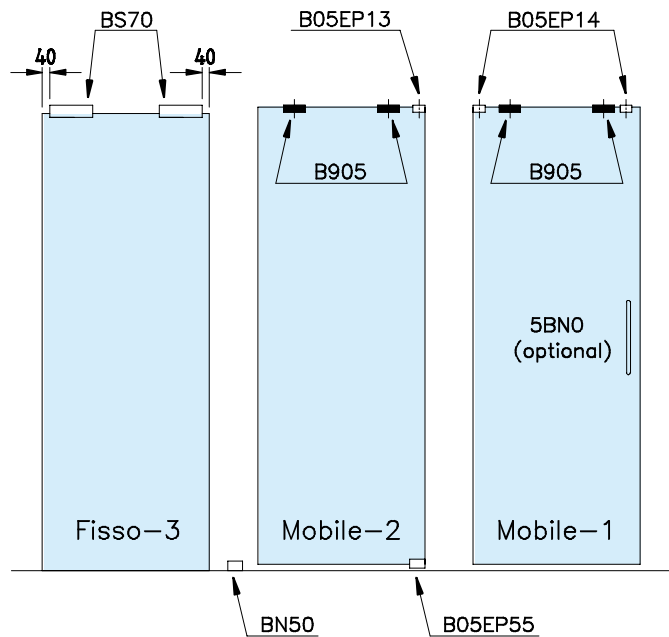



**B05E76**

In caso di dimensioni della barra superiore a 6mt. utilizzare due barre  
In case of bar dimensions higher than 6mt. use 2 bars

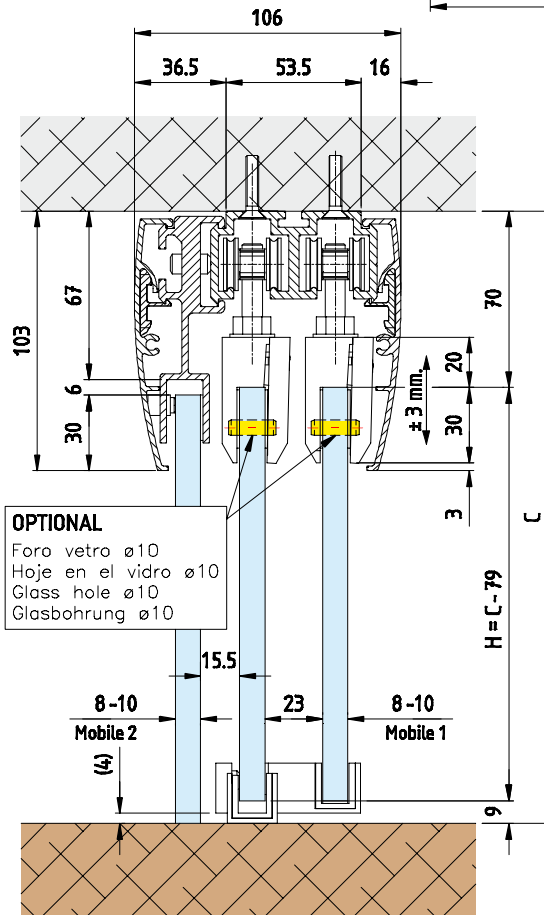
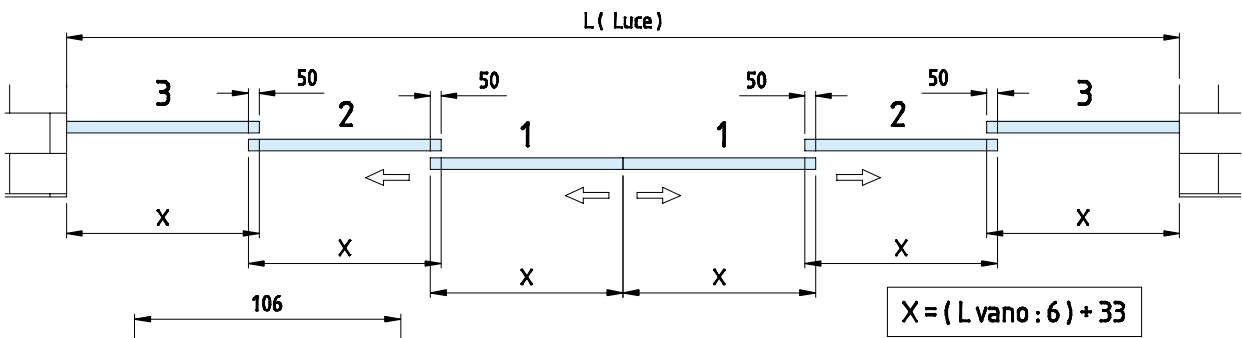
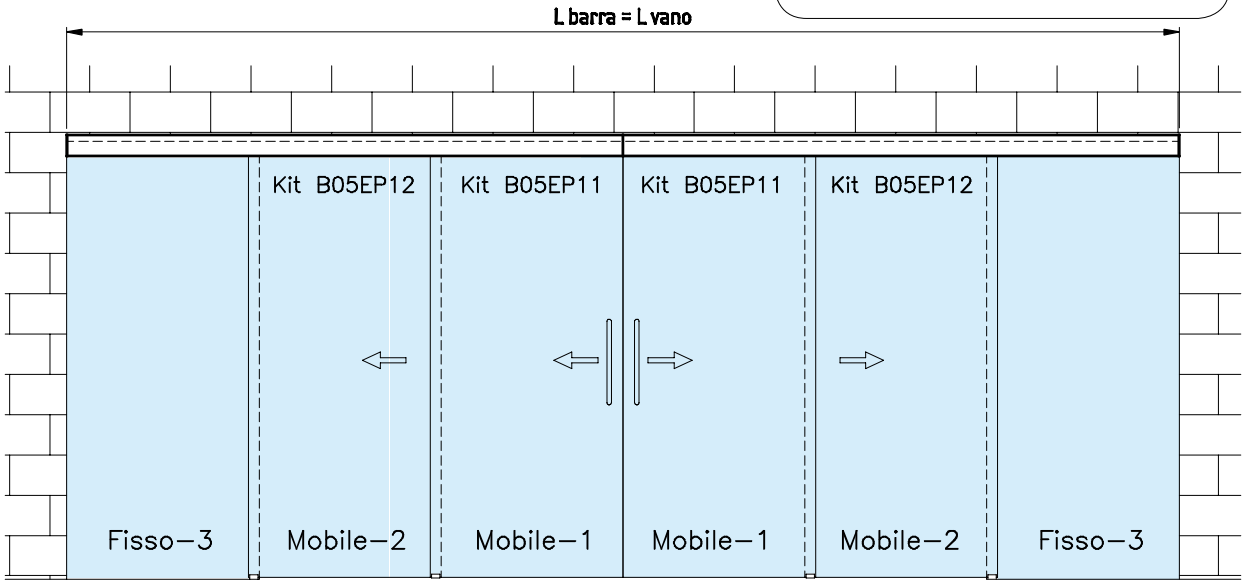

Kit B05EP12    Kit B05EP11

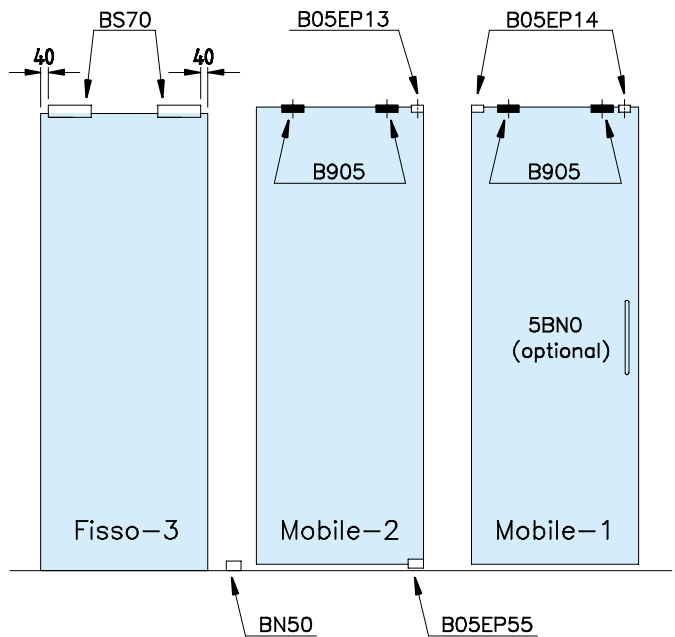

Sistema Slak-T - Sistema Slak-T - Slak-T system - Slak-T System

Slak-T **B05E** DETTAGLI DETALLES DETAILS DETAILLE

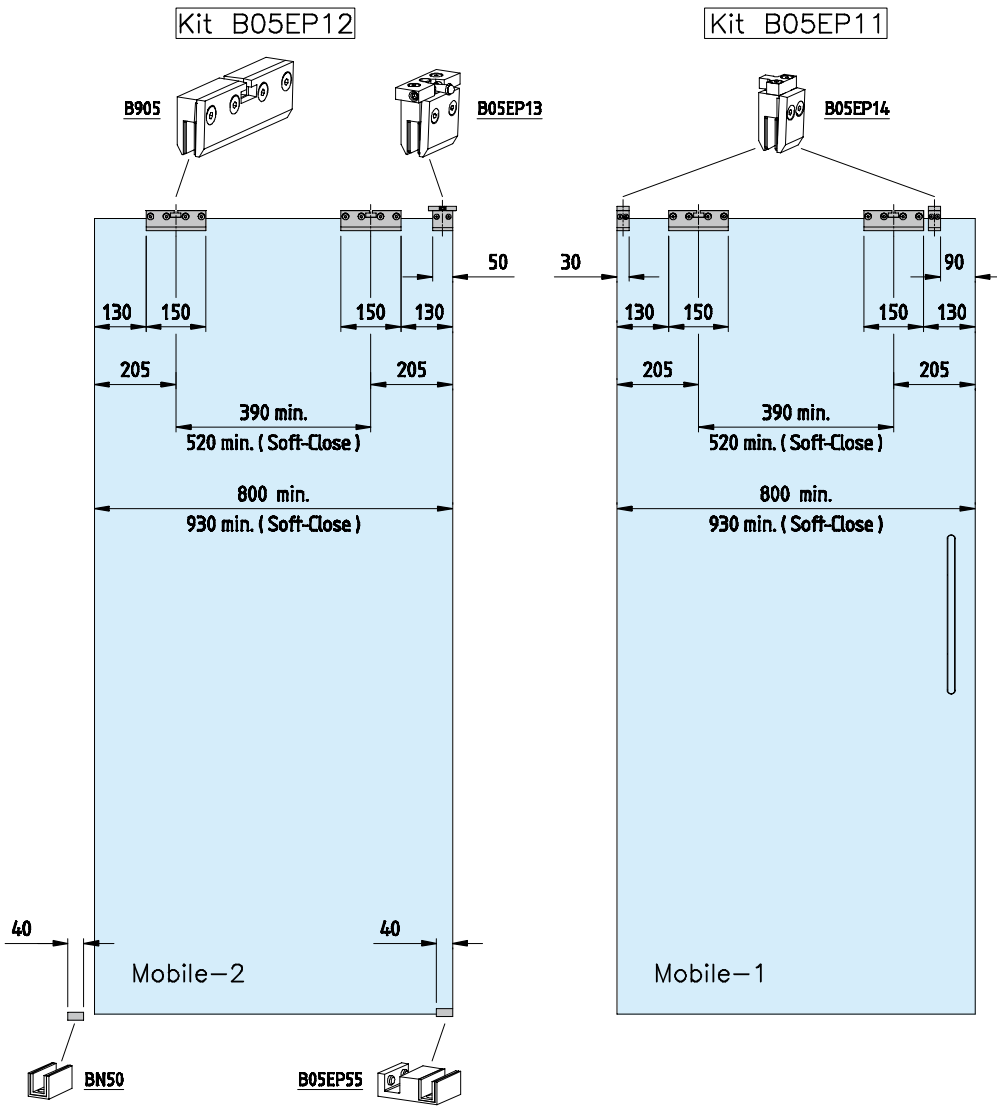

ESEMPIO - EJEMPLO  
EXAMPLE - BEISPIEL

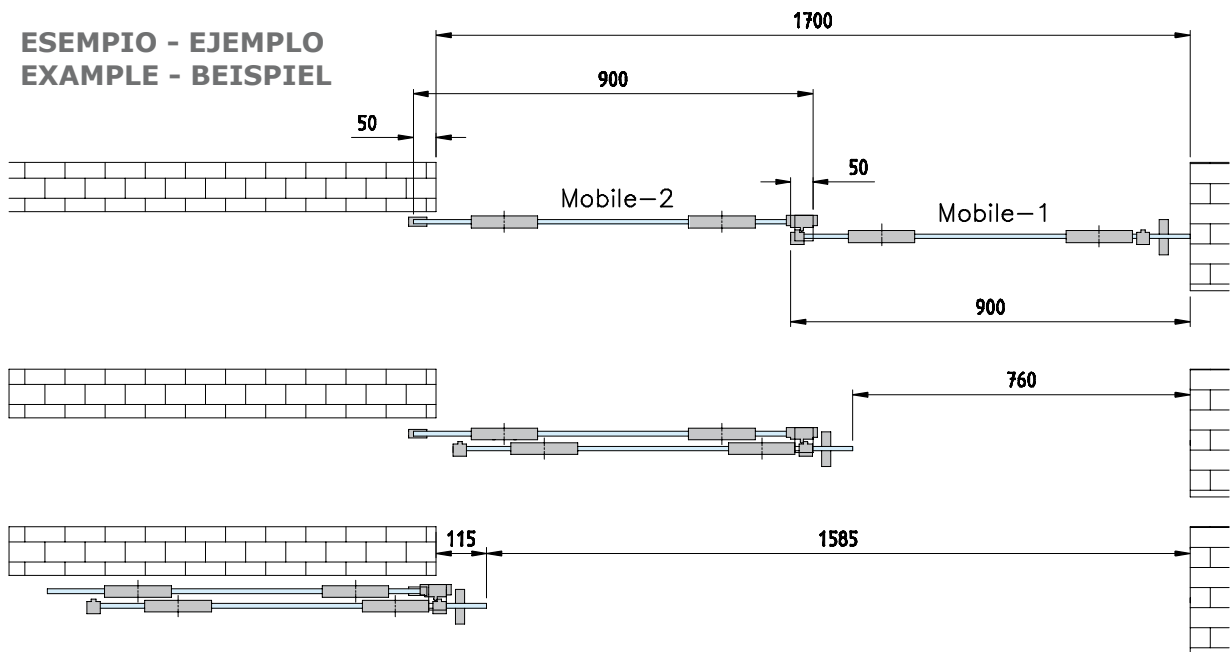

Sistema Slak-T - Sistema Slak-T - Slak-T system - Slak-T System