

P35E

5,8m. NEW STRIPE

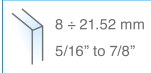

• Profilo telaio per porte in vetro.
Per vetri porta di 8-10-12mm (5/16" to 7/8").
Fissaggio a muro o su vetro.
Da abbinare a P35E61 o P35E62.

• Perfil marco para puertas en vidrio.
Sujeta vidrios de 8-10-12mm (5/16" to 7/8").
Fijación a pared o a vidrio.
Combinar con P35E61 o P35E62.

• Profile for 8-10-12mm (5/16" to 7/8") glass doors.
Mountable on standard walls or glass.
To be matched with P35E61 or P35E62.

• Zargenprofil für Glastüren.
Glasdicke von 8-10 bis 12mm (5/16" to 7/8").
Befestigung an der Mauer oder am Glas.
Mit P35E61 oder P35E62 kombinieren.

• Profilé pour porte en verre.
Pour verre de 8-10-12mm (5/16" to 7/8").
Fixation au mur ou sur verre.
Avec P35E61 ou P35E62 combiner.

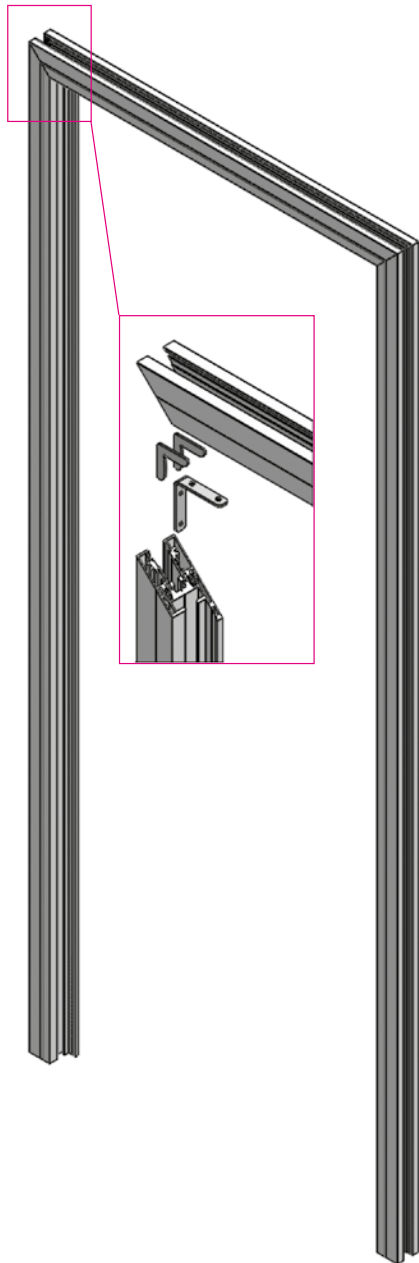

P35E60

Fissaggio a muro / Wall fixing

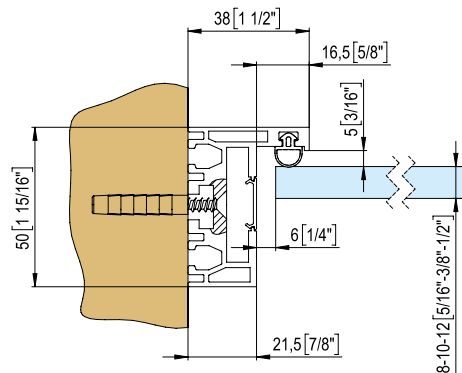

P35E60 + P35E61

Fissaggio a vetro / Glass fixing

Spessore / Thickness 8 + 13.52 mm [5/16" to 9/16"]

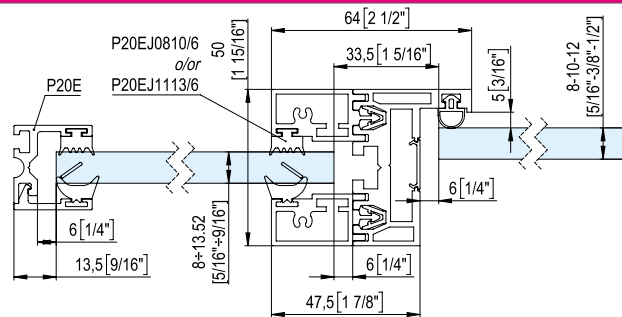

Guarnizioni per fissaggio a vetro da ordinare in base allo spessore del vetro
Gaskets for glass fixing to be purchased according to the glass thickness

P20EJ0810/6



Coppia di guarnizioni L=5.8m.
Pareja de guarniciones L=5.8m.
Pair of gaskets L=5.8m.
Paar Dichtungsbänder L=5.8m.
Paire de garniture L=5.8m.

P20EJ1113/6

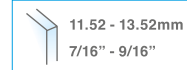

Coppia di guarnizioni L=5.8m.
Pareja de guarniciones L=5.8m.
Pair of gaskets L=5.8m.
Paar Dichtungsbänder L=5.8m.
Paire de garniture L=5.8m.

P35E60 + P35E62

Fissaggio a vetro / Glass fixing

Spessore / Thickness 16.76 + 21.52 mm [11/16" to 7/8"]

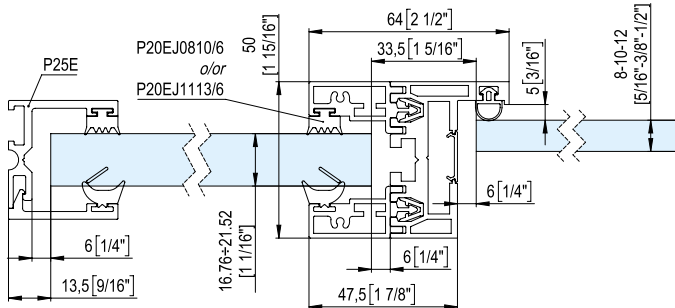

Guarnizioni per fissaggio a vetro da ordinare in base allo spessore del vetro
Gaskets for glass fixing to be purchased according to the glass thickness

P20EJ0810/6

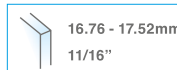

Coppia di guarnizioni L=5.8m.
Pareja de guarniciones L=5.8m.
Pair of gaskets L=5.8m.
Paar Dichtungsbänder L=5.8m.
Paire de garniture L=5.8m.

P20EJ1113/6

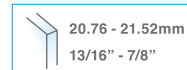

Coppia di guarnizioni L=5.8m.
Pareja de guarniciones L=5.8m.
Pair of gaskets L=5.8m.
Paar Dichtungsbänder L=5.8m.
Paire de garniture L=5.8m.

P35E60 Compresso / Including

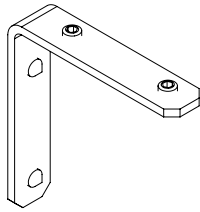

P35EP22 (x2)

Squadra di fissaggio
Escuadra de fijación
Mounting bracket
Befestigungswinkel
Équerre de fixation



P35EG43/3 (x2)

Profilo copriviti L = 3000 mm / [118 1/8"]
Perfil tapas de los tornillos L = 3000 mm / [118 1/8"]
Profile screw covers L = 3000 mm / [118 1/8"]
Profil Schraubenabdeckungen L = 3000 mm / [118 1/8"]
Profil couvercles à vis L = 3000 mm / [118 1/8"]

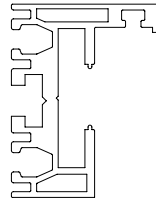

P35EG40/6 (x1)

Profilo battuta L = 5800 mm / [228 3/8"]
Perfil para jamba L = 5800 mm / [228 3/8"]
Profile for doors with rebate L = 5800 mm / [228 3/8"]
Profil für Türen mit Stop L = 5800 mm / [228 3/8"]
Profil en butée L = 5800 mm / [228 3/8"]



P35EJ01/6 (x1)

Guarnizione per porta L = 5800 mm / [228 3/8"]
Sellar para puertas L = 5800 mm / [228 3/8"]
Seal for door, length L = 5800 mm / [228 3/8"]
Türdichtung für Seitenteil Befestigung L = 5800 mm / [228 3/8"]
Joints pour porte L = 5800 mm / [228 3/8"]

P35E61 Compresso / Including

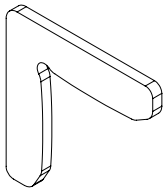

PDAUG07 (x4)

Piatto di allineamento
Platillo de alineación
Alignment plate
Ausgleichplatte
Plateau d'alignement

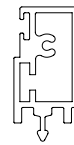

P35EG41/6 (x2)

Profilo ferma vetro L = 5800 mm / [228 3/8"]
Perfil parada de vidrio L = 5800 mm / [228 3/8"]
Profile glass stop L = 5800 mm / [228 3/8"]
Profil glas stop L = 5800 mm / [228 3/8"]
Profil arrêt de verre L = 5800 mm / [228 3/8"]



JDAUV40 (x9)

Guarnizione ad incastro L = 1400 mm / [55 1/8"]
Sellar entrelazado L = 1400 mm / [55 1/8"]
Seal joint, length L = 1400 mm / [55 1/8"]
Türdichtung ineinandergreifend L = 1400 mm / [55 1/8"]
Joints s'emboitant L = 1400 mm / [55 1/8"]

P35E62 Compresso / Including

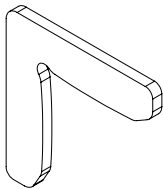

PDAUG07 (x4)

Piatto di allineamento
Platillo de alineación
Alignment plate
Ausgleichplatte
Plateau d'alignement

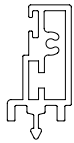

P35EG42/6 (x2)

Profilo ferma vetro L = 5800 mm / [228 3/8"]
Perfil parada de vidrio L = 5800 mm / [228 3/8"]
Profile glass stop L = 5800 mm / [228 3/8"]
Profil glas stop L = 5800 mm / [228 3/8"]
Profil arrêt de verre L = 5800 mm / [228 3/8"]



JDAUV40 (x9)

Guarnizione ad incastro L = 1400 mm / [55 1/8"]
Sellar entrelazado L = 1400 mm / [55 1/8"]
Seal joint, length L = 1400 mm / [55 1/8"]
Türdichtung ineinandergreifend L = 1400 mm / [55 1/8"]
Joints s'emboitant L = 1400 mm / [55 1/8"]

Non compresso / Not included

P20E

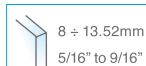

P20EC

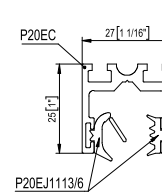
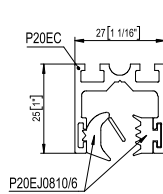
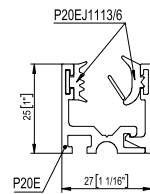
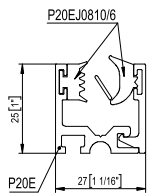

P25E

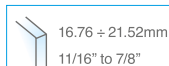

P25EC

